

JUKI®

1-needle, Bottom-feed, Lockstitch Machine
with Vertical Edge Trimmer and Automatic Thread Trimmer

DLM-5400N-7



DLM-5400N-7-WB/CP-160A

1-needle, Needle-feed, Lockstitch Machine
with Vertical Edge Trimmer and Automatic Thread Trimmer

DMN-5420N-7



DMN-5420N-7-WB/CP-160A

With its highly operable knife mechanism, the machine helps promote the production of upgraded-quality products while increasing efficiency.

The stitch quality is consistent even during high-speed operation.

Capable of high-speed sewing, it can also flexibly respond to various applications, thus leading to higher productivity.

The one-touch utility knife lever enhances the comfort of operation.

Since the knife lever has been plated so as to prevent rust, there is no need to worry about the material becoming soiled with rust.



The knife is sharp enough to cut any type of material.

The knife is capable of cutting any kind of material regardless of its thickness or toughness, including heavy-weight material, elastic material and brushing material.

Sure thread trimming mechanism.

The thread trimmer is designed to cut various threads of different thicknesses, so the range of the applicable thread thickness number has been widened. The thread trimmer can therefore cut even a thick thread with ease.



Adjustment of the position of the cloth trimming knife.

The cloth trimming knife has been designed so that it can move as much as 5.5mm toward you from the center of the needle.

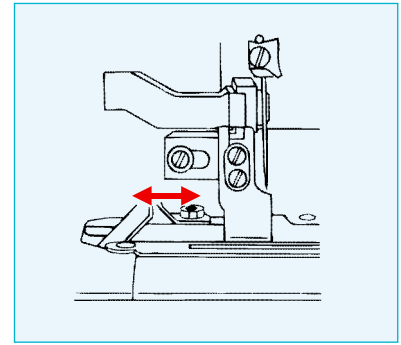

OPTIONS (With its full array of options, the machine further increases productivity.)

● Auto-lifter AK85 (pedal-driven)



● Remaining bobbin thread detector AE-4* Part No.: GAE-04000A0

When the amount of remaining bobbin thread reaches the setting, the buzzer will sound to warn the operator not to press on the front part of the foot pedal. With this function, the operator doesn't have to look away from the sewing work to check the bobbin thread.

*To retrofit the AE-4 to your existing machine, I/O unit A (part number: 400-06080), which is separately available, is required.

● Material edge sensor ED-2

When the sensor detects a material edge, it immediately stops the sewing machine and actuates the thread trimmer. This enhances productivity by allowing the operator to conduct sewing work without running to look out for missing stitches.

Newly developed control box/Compact motor unit

SC-910/M91

¥ SC-910 model control box is resistant to voltage fluctuations. It comes with a compact and energy-saving type switching power supply system that does not use a transformer. This contributes to improved reliability.

¥ The M91 model compact motor unit featuring low vibration and low noise capabilities is installed on the control box.

¥ The number of revolutions can be selected from among three different types (standard, slow and fast) according to the preference of the operator. In addition to this feature, the control box incorporates many different functions for upgraded workability.



The operation panel can be selected according to the process.

IP-100C

¥ The operation panel has been provided with a large user-friendly LCD. A pictograph and set values are shown on the same screen, which promises improved operability of the panel.

¥ The operation panel has been provided with a variety of communication and maintenance control features and is able to store data on a SmartMedia or personal computer.

¥ The features of the operation panel can be updated without the need for changing the PWB/ROM.



CP-160A









¥ Pattern sewing can be performed by the number of stitch control feature.

¥ Four different kinds of pattern sewing are possible: automatic reverse stitching, constant-dimension sewing, rectangle-shape sewing, and multi-layer stitching. The maximum number of stitches that can be set for automatic reverse stitching (single or double) is 19.



DLM-5400N-7









SUB-GAUGE SET LIST

Specifications of the sub-gauge	Gauge width	Throat plate	Throat plate cover (asm.)	Gauge	Throat plate chip guard	Chip guide	Hinging presser (asm.)	Feed dog	Knife
									
**C	2.4mm (3/32")	113-46004	B1115-531-0AD	B1190-522-X00	113-46905	113-46400	B1524-530-DB0	B1613-522-N00A	B4121-522-000
D	3.2mm (1/8")	113-46004	B1115-531-0AD	B1190-522-S00	113-46905	113-46400	B1524-530-DB0	B1613-522-N00A	B4121-522-000
E	4.0mm (5/32")	113-46004	B1115-531-0AD	B1190-522-Y00	113-46905	113-46400	B1524-530-EB0	B1613-522-N00A	B4121-522-000
F	4.8mm (3/16")	113-46004	B1115-530-0AF	B1190-522-T00	113-46905	113-46400	B1524-530-EB0	B1613-522-N00A	B4121-522-000
H	6.4mm (1/4")	113-46004	B1115-530-0AF	B1190-522-U00	113-47101	113-46509	B1524-530-GB0	B1613-522-W00A	B4121-522-000
M	9.5mm (3/8")	113-46004	B1115-530-0AM	B1190-522-V00	113-47309	113-46509	B1524-530-GB0	B1613-522-W00A	B4121-522-000
■ This is made to order as an auxiliary part only.									
**CA	2.0mm (5/64")	113-46004	B1115-531-0AD	B1190-522-Y0A	113-46905	113-46400	B1524-530-CB0	B1613-522-N00A	B4145-530-C00
CB	2.4mm (3/32")	113-46004	B1115-531-0AD	B1190-522-X0B	113-46905	113-46400	B1524-530-DB0	B1613-522-N0C	B4121-522-000
EA	4.0mm (5/32")	113-46004	B1115-531-0AD	113-62753	113-46905	113-46400	B1524-530-EB0	B1613-522-N00A	B4121-522-000
FA	4.8mm (3/16")	113-46004	B1115-530-0AF	B1190-522-T0A	113-46905	113-46400	B1524-530-EB0	B1613-522-N00A	B4121-522-000
FB	4.8mm (3/16")	113-46004	B1115-530-0AF	B1190-522-Y0C	113-46905	113-46400	B1524-530-EB0	B1613-522-N00A	B4121-522-000
G	5.3mm (27/128")	113-46004	B1115-530-0AF	B1190-522-Y0F	113-47101	113-46400	B1524-530-GB0	B1613-522-N00A	B4121-522-000
HA	6.4mm (1/4")	113-46301	B1115-530-0AF	B1190-522-U0AA	113-47101	113-46509	B1524-530-GB0	B1613-522-A0AA	B4121-522-000
K	7.9mm (5/16")	113-46004	B1115-530-0AF	B1190-522-Y0B	113-47101	113-46509	B1524-530-GB0	B1613-522-W00A	B4121-522-000
MA	9.5mm (3/8")	113-46004	B1115-530-0AM	B1190-522-V0A	113-47309	113-46509	B1524-530-GB0	B1613-522-B00	B4121-522-000
*P	11.1mm (7/16")	113-46004	B1115-530-0AM	B1190-522-Y0M	113-47309	113-46608	B1524-530-GB0	B1613-522-W00A	B4121-522-000

*Knife support replacement B4118-530-00A knife attaching block replacement B4119-530-00A are also available.
 **Wiper cannot be attached to the C and CA type of sub-gauges.

DMN-5420N-7

SUB-GAUGE SET LIST

Specifications of the sub-gauge	Gauge width	Throat plate	Throat plate cover (asm.)	Gauge	Throat plate chip guard	Chip guide	Hinging presser (asm.)	Feed dog	Knife
									
**D	3.2mm (1/8")	113-46004	B1115-531-0AD	B1190-530-D00	113-46905	113-46400	B1524-530-DB0	B1609-530-D00 B1609-530-E00	B4121-522-000
E	4.0mm (5/32")	113-46004	B1115-530-0AF	B1190-530-E00	113-46905	113-46400	B1524-530-EB0	B1609-530-D00 B1609-530-E00	B4121-522-000
F	4.8mm (3/16")	113-46004	B1115-530-0AF	B1190-530-F00	113-46905	113-46400	B1524-530-EB0	B1609-530-D00 B1609-530-E00	B4121-522-000
G	5.6mm (7/32")	113-46004	B1115-530-0AF	B1190-530-G00	113-47101	113-46400	B1524-530-GB0	B1609-530-G00 B1609-530-H00	B4121-522-000
H	6.4mm (1/4")	113-46103	B1115-530-0AF	B1190-530-H00	113-47101	113-46509	B1524-530-GB0	B1609-530-G00 B1609-530-H00	B4121-522-000
M	9.5mm (3/8")	113-46103	B1115-530-0AM	B1190-530-M00	113-47309	113-46509	B1524-530-GB0	B1609-530-G00 B1609-530-H00	B4121-522-000
■ This is made to order as an auxiliary part only.								★★Coarse feed dog	
*CA★	2.0mm (5/64")	113-46004	B1115-531-0AD	B1190-530-C0A	113-46905	113-46400	B1524-530-CB0	B1609-530-C0A	B4121-530-C00
DA★	2.8mm (7/64")	113-46004	B1115-531-0AD	B1190-522-D0A	113-46905	113-46400	B1524-530-DB0	B1609-530-D00 B1609-530-E00	B4121-522-000
**DC	3.2mm (1/8")	113-46004	B1115-531-0AD	B1190-530-D0C	113-46905	113-46400	B1524-530-DB0	B1609-530-D0E	B4121-522-000
DD	3.2mm (1/8")	113-46004	B1115-530-0AD	B1190-530-D0B	113-46905	113-46400	B1524-530-DBA	B1609-530-J00	B4121-522-000
J	7.5mm (9/32")	113-46103	B1115-530-0AF	B1190-530-J00	113-47101	113-46509	B1524-530-GB0	B1609-530-G00 B1609-530-H00	B4121-522-000
JA	7.5mm (9/32")	113-46103	B1115-530-0AF	B1190-530-J0A	113-47101	113-46509	B1524-530-GB0	B1609-530-G00 B1609-530-H00	B4121-522-000
K	7.9mm (5/16")	113-46103	B1115-530-0AM	B1190-530-K00	113-47309	113-46509	B1524-530-GB0	B1609-530-G00 B1609-530-H00	B4121-522-000

*Be sure to use this gauge with the stitch length set to 2mm or less.
 **Be sure to use this gauge with the stitch length set to 2.5mm or less.
 ★ Wiper cannot be attached to the CA and DA type of sub-gauges.

SPECIFICATIONS

Model name	DLM-5400N-7	DMN-5420N-7
Max. sewing speed	4,500rpm	5,000rpm (Max. 4,000rpm with the stitch length set to 4mm or more)
Feed system	Bottom-feed	Needle-feed
Max. stitch length	4mm (normal/reverse feed)	5mm (normal feed), 3mm (reverse feed)
Needle bar stroke	30.7mm	
Lift of the presser foot	By hand : 5.5mm, By knee : 10mm	
Needle (at the time of delivery)	DB×1 (#14) #9~#18, For JE: 134 (Nm90)	
Hook	Automatic-lubricating full-rotary hook	
Max. thickness of the material to be cut	4mm	
Lubrication	Automatic	
Lubricating oil	JUKI New Defrix Oil No.1 (equivalent to ISO VG7)	
Automatic reverse feed function	Provided as standard	
Power requirement	Single-phase 100~120V, 200~240V, 3-phase 200~240V	
Power consumption	650VA	
Total weight	83kg	84kg

WHEN YOU PLACE ORDERS

Please note when placing orders, that the model name should be written as follows:

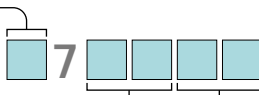
DLM5400N 

Sub-gauge type	
Distance between the needle and the knife	Code
3.2mm (1/8") standard	D
2.4mm (3/32")	C
4.0mm (5/32")	E
4.8mm (3/16")	F
6.4mm (1/4")	H
9.5mm (3/8")	M

Wiper and automatic reverse feed function		
Wiper	Automatic reverse feed function	Code
Not provided	Provided	0B
Provided	Provided	WB

Auto-lifter (optional)	Code
Not provided	
Provided (AK85)	AK

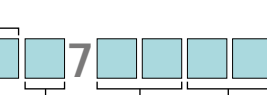
DMN5420N 

Sub-gauge type	
Distance between the needle and the knife	Code
3.2mm (1/8") standard	D
4.0mm (5/32")	E
4.8mm (3/16")	F
5.6mm (7/32")	G
6.4mm (1/4")	H
9.5mm (3/8")	M

Feed dog	Code
Standard	A
Coarse feed dog	B

Wiper and automatic reverse feed function		
Wiper	Automatic reverse feed function	Code
Not provided	Provided	0B
Provided	Provided	WB

Auto-lifter (optional)	Code
Not provided	
Provided (AK85)	AK

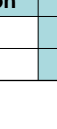
● PSC box **SC910** 

PSC box				Code
For JUS (LA)*	Single-phase	100~120V	PFL	S
For JUS*, General Export	3-phase	200~240V	PFL	D
For General Export	Single-phase	200~240V	PFL	K
For EU (CE)	Single-phase	200~240V	PFL	N
For China	Single-phase	200~240V	PFL	U

Control box		Code
Standard		S
Provided with built-in I/O board		A

● Motor for SC **M91S**

Pulley belt	Code
Standard	S

● Control box provided with built in I/O board (Code A) should be selected for the machine head equipped with the remaining bobbin thread detector (AE-4).

*JUS: North America and Central and South America

● Operation panel

Operation panel	Code
IP-100C	IP100C
CP-160A	CP160A

● To order, please contact your nearest JUKI distributor.

JUKI
JUKI CORPORATION
MARKETING & SALES H.Q.

8-2-1, KOKURYO-CHO, CHOFU-SHI,
 TOKYO 182-8655, JAPAN
 PHONE : (81) 3-3480-2357, 2358
 FAX : (81) 3-3430-4909, 4914
<http://www.juki.com>



JUKI CORPORATION HEAD OFFICE
 The environmental management system to promote and conduct the technological and technical research, the development and design of the products in which the environmental impact is considered, the conservation of the energy and resources, and the recycling in the research, development, design, distribution, sale and maintenance service of the industrial sewing machines, household sewing machines and industrial-use robots, etc. and in the sale and maintenance service of the data entry system and in the purchase, distribution and sale of the household commodities including the healthcare products.

* Specifications and appearance are subject to change without prior notice for improvement.
 * Read the instruction manual before putting the machine into service to ensure safety.
 * This catalogue prints with environment-friendly soy ink on recycle paper.